



HOUGHTON
UNIVERSITY

Target Normal Sheath Acceleration as a Technique to Measure Cross Sections

Andrew Martin

Department of Physics, Houghton University, One Willard Ave, Houghton, NY, 14744



What are Light Ion Cross Sections?

Protons ↑

	¹⁰ N p	¹¹ N p	¹² N 11 ms β+	¹³ N 9.97 m β+	¹⁴ N	¹⁵ N	¹⁶ N 7.1 s β-	¹⁷ N 4.2 s β-
⁸ C p, α	⁹ C 127 ms β+, p	¹⁰ C 19.3 s β+	¹¹ C 20.4 s β+	¹² C	¹³ C	¹⁴ C 5700 y β-	¹⁵ C 2.4 s β-	¹⁶ C 747 ms β-
⁷ B p, α	⁸ B 770 ms β+, α	⁹ B p, α	¹⁰ B	¹¹ B	¹² B 20.2 ms β-	¹³ B 17.3 ms β-	¹⁴ B 12.4 ms β-	¹⁵ B 10.2 ms β-
⁶ Be p, α	⁷ Be 53 d β+	⁸ Be α	⁹ Be	¹⁰ Be 1.5×10 ⁶ y β-	¹¹ Be 13.7 s β-	¹² Be 21.5 ms β-	¹³ Be n	¹⁴ Be 4.4 ms β-
⁵ Li p, α	⁶ Li	⁷ Li	⁸ Li 840 ms β-	⁹ Li 178 ms β-	¹⁰ Li n			
⁴ He	⁵ He n	⁶ He 807 ms β-	⁷ He n	⁸ He 119 ms β-	⁹ He n			
³ He 12 y β-	⁴ H n	⁵ H 2n	⁶ H n	⁷ H 2n				

Neutrons →

Disadvantage of Traditional Activation Experiments

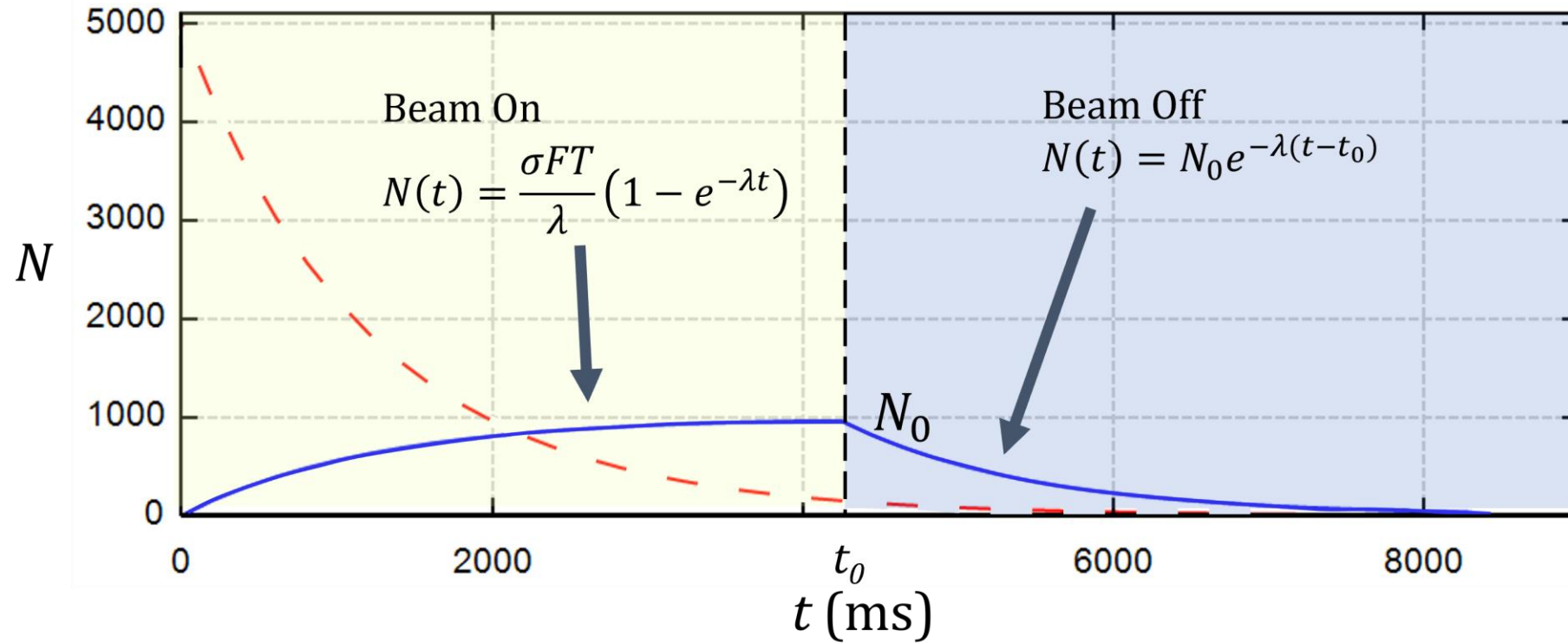

Target Normal Sheath Acceleration Experiment



MTW, Omega or EP

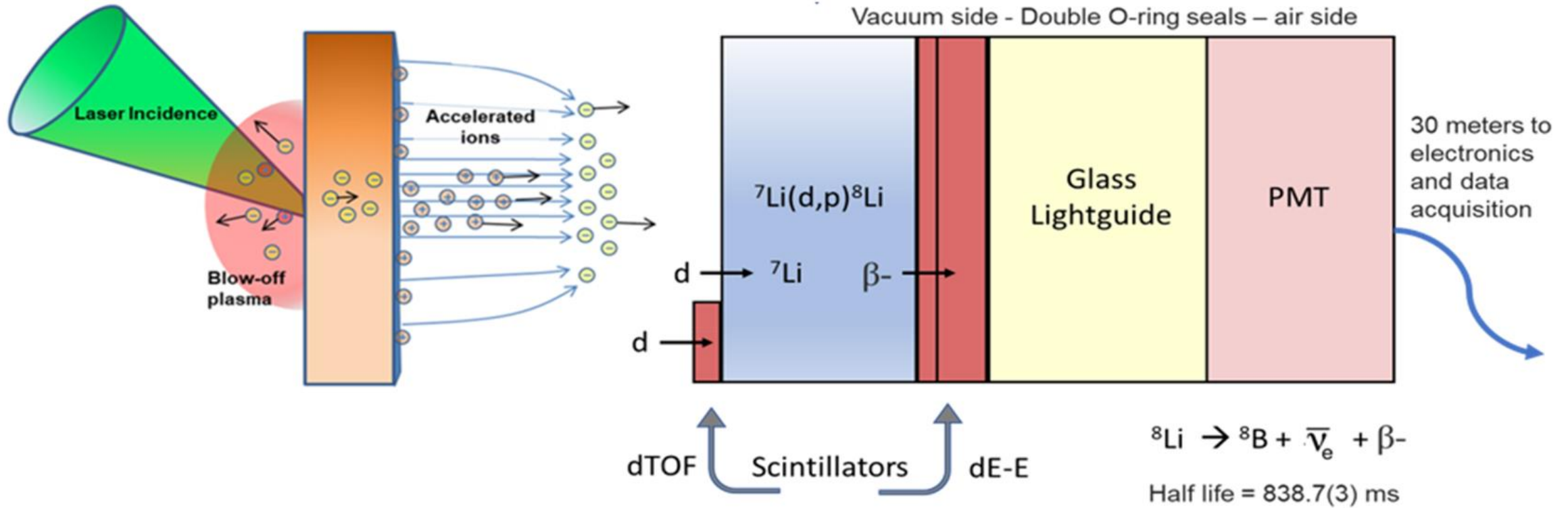

MTW Laser

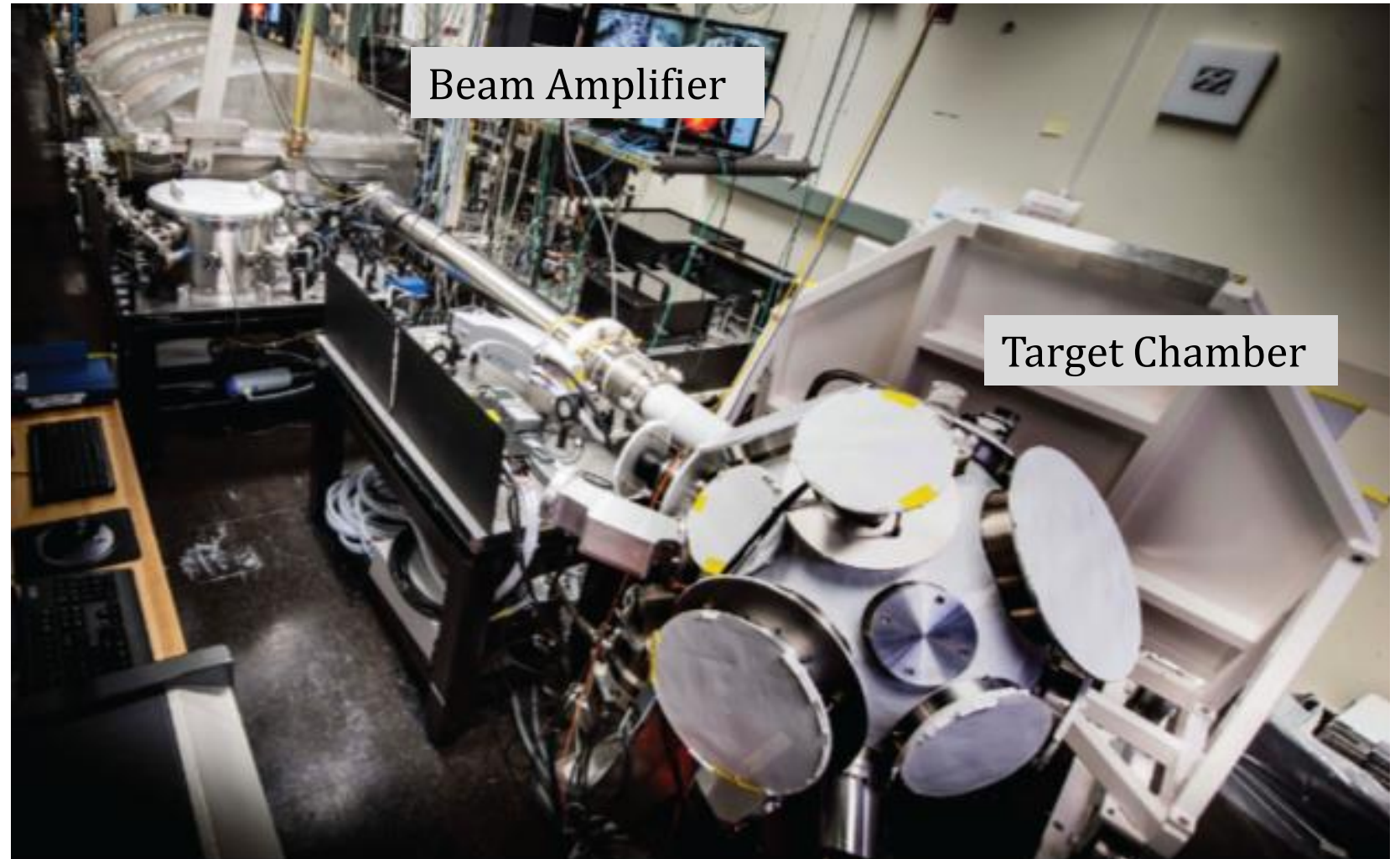

Beam Amplifier

Target Chamber

Target Chamber

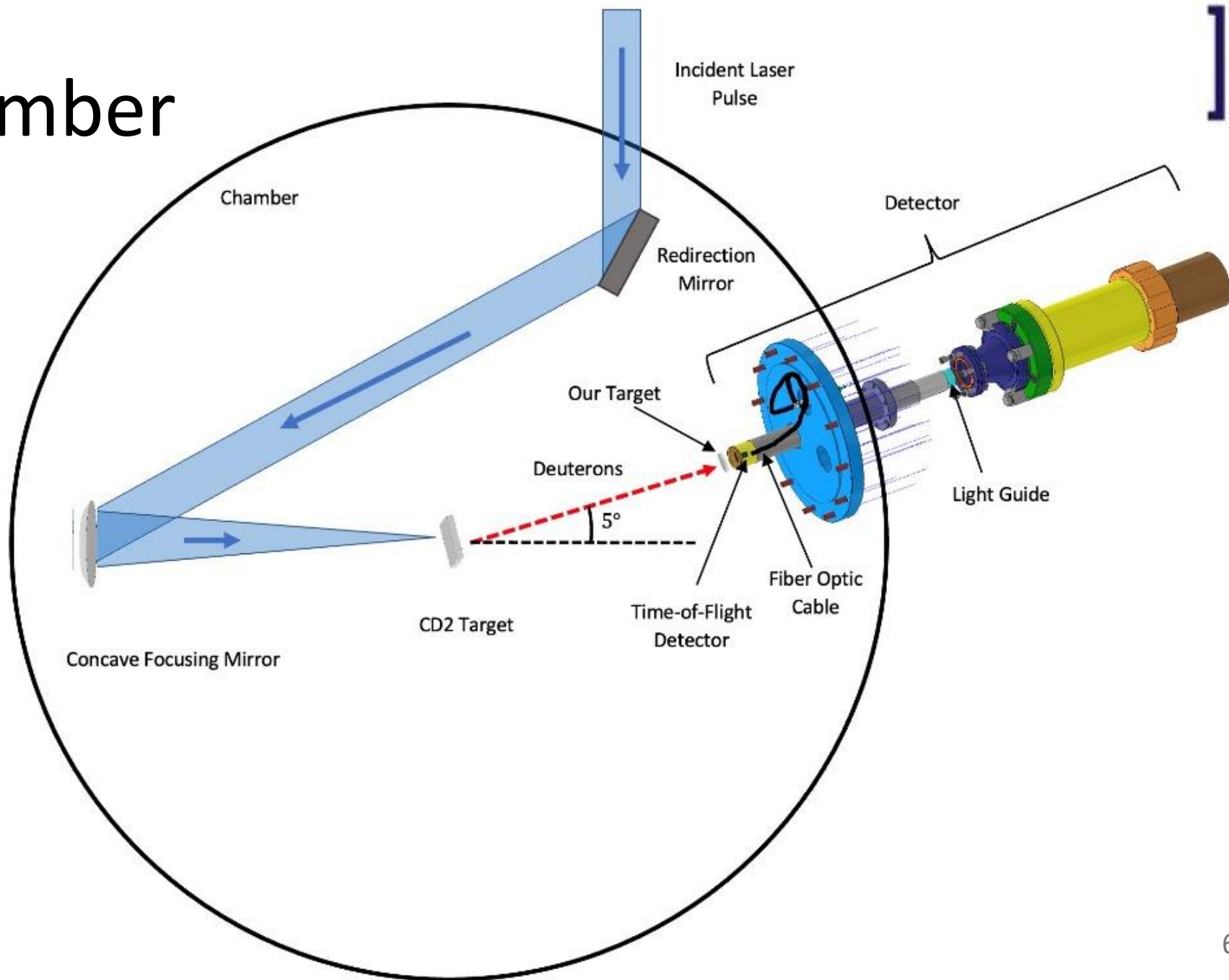

Time of Flight Detector

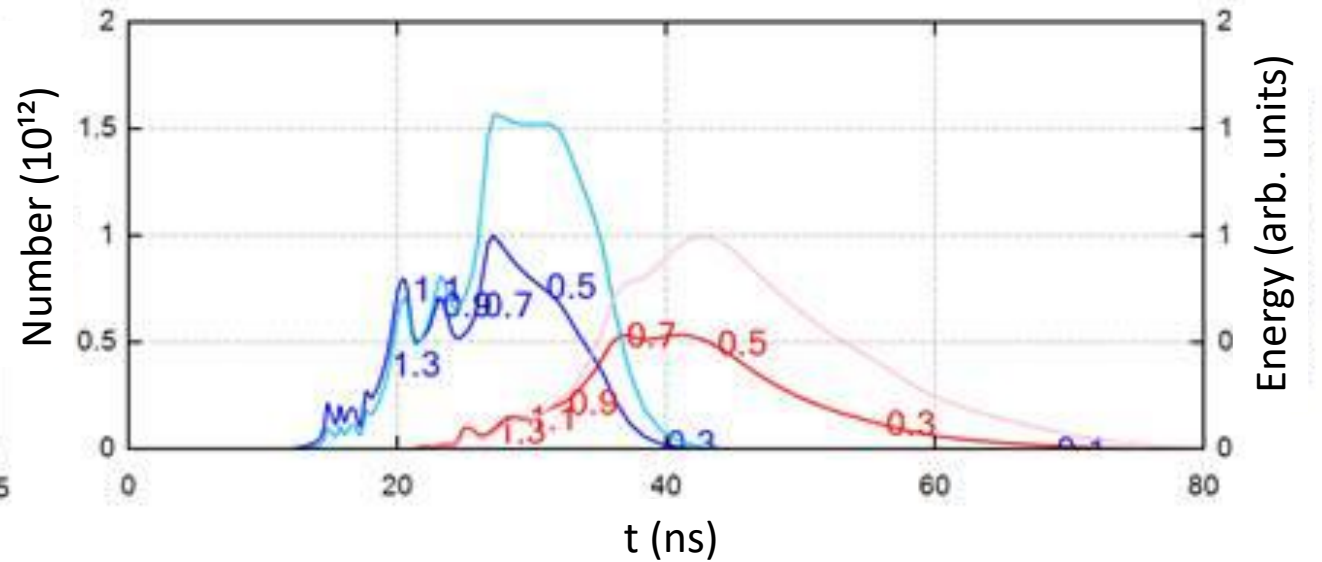
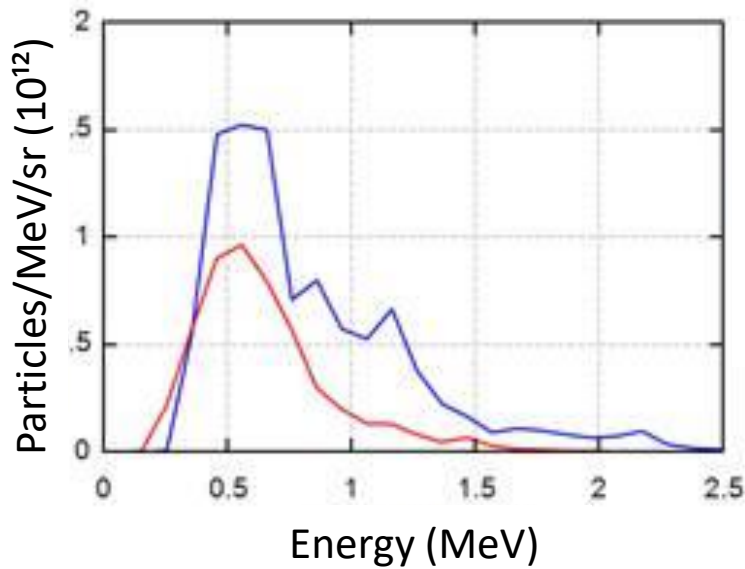
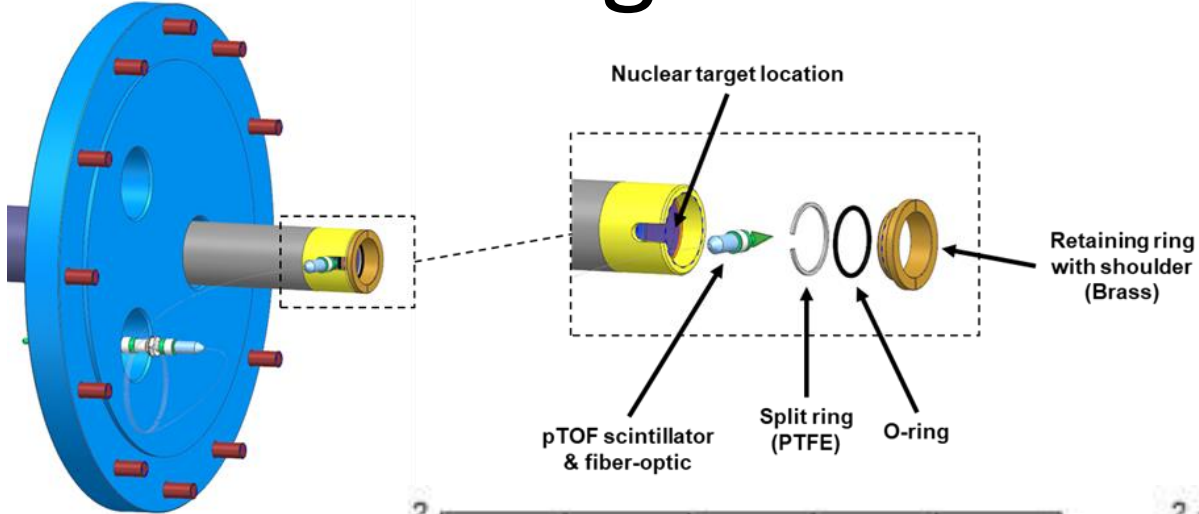



Phoswich Detector

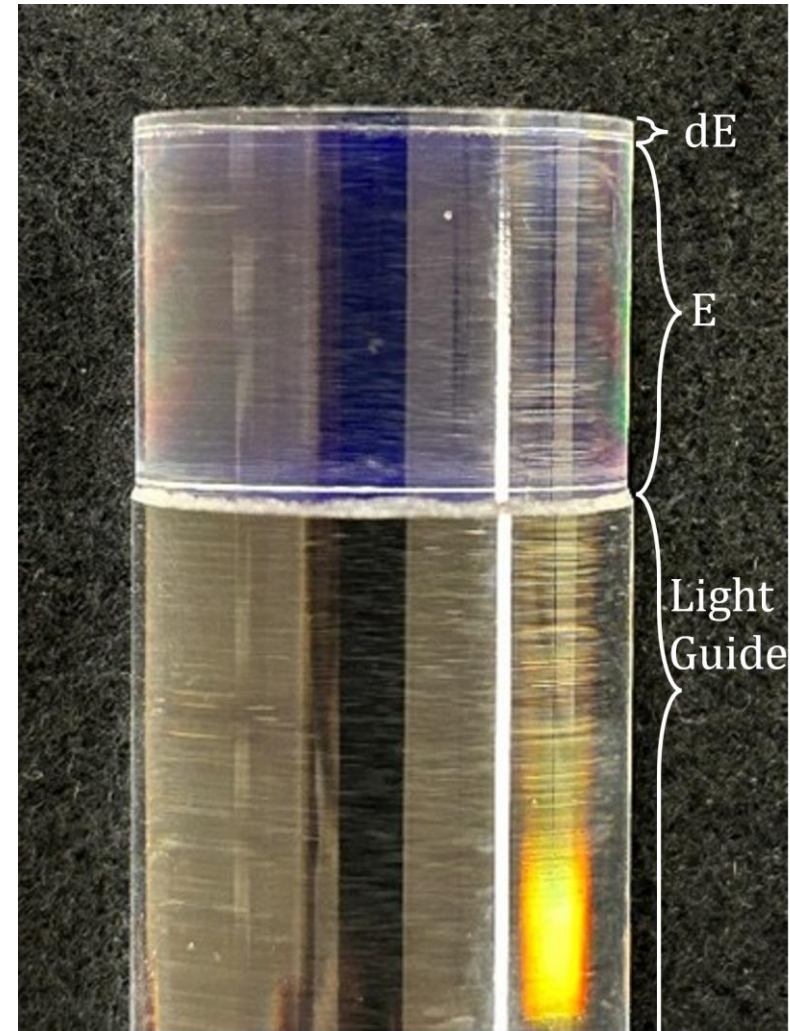
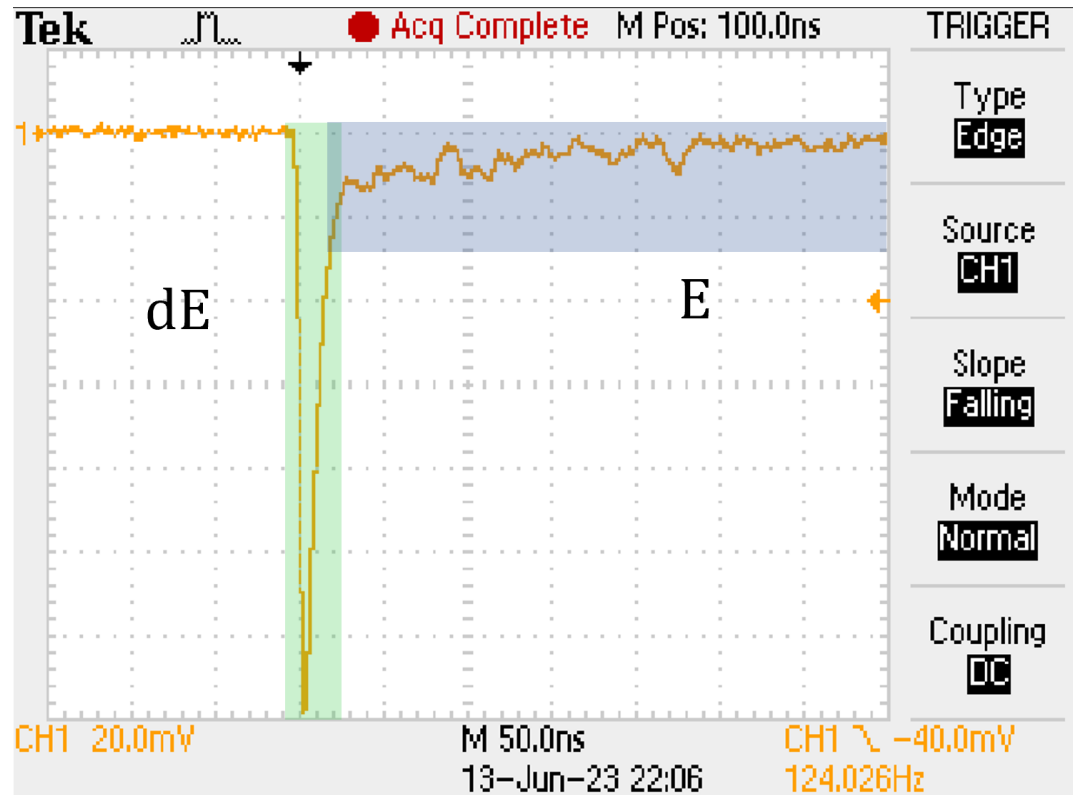

Phoswich

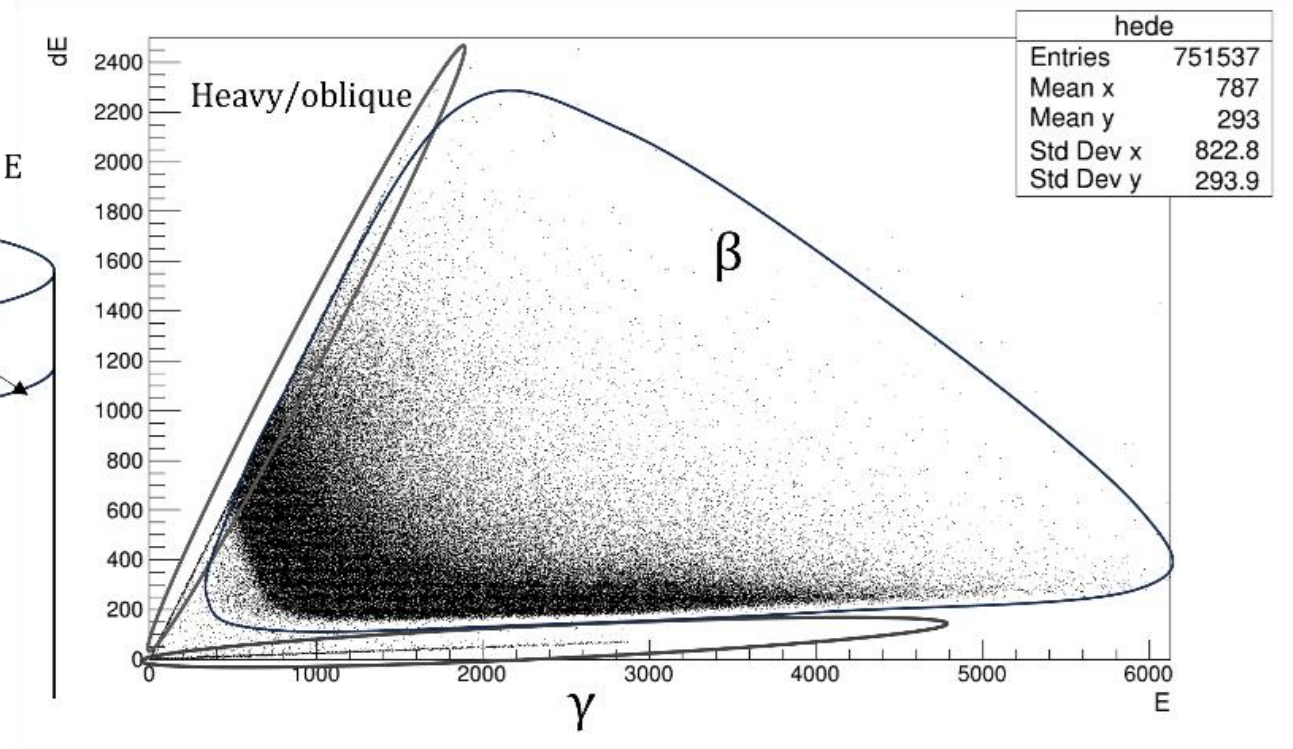
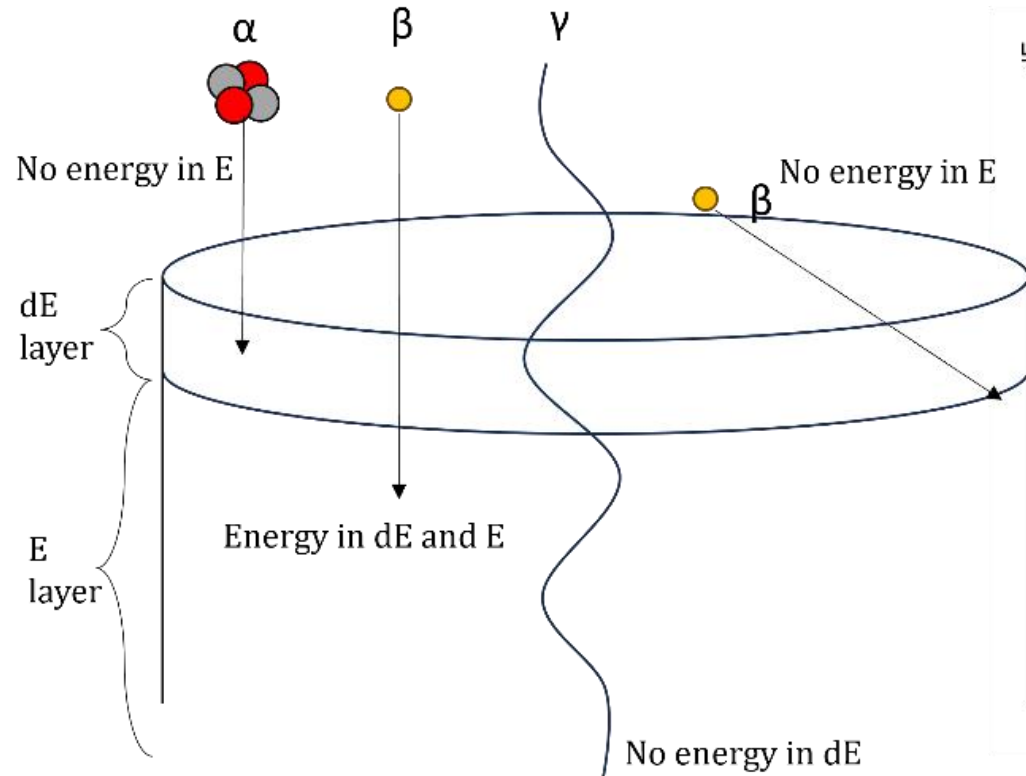



Example 2D Histograms

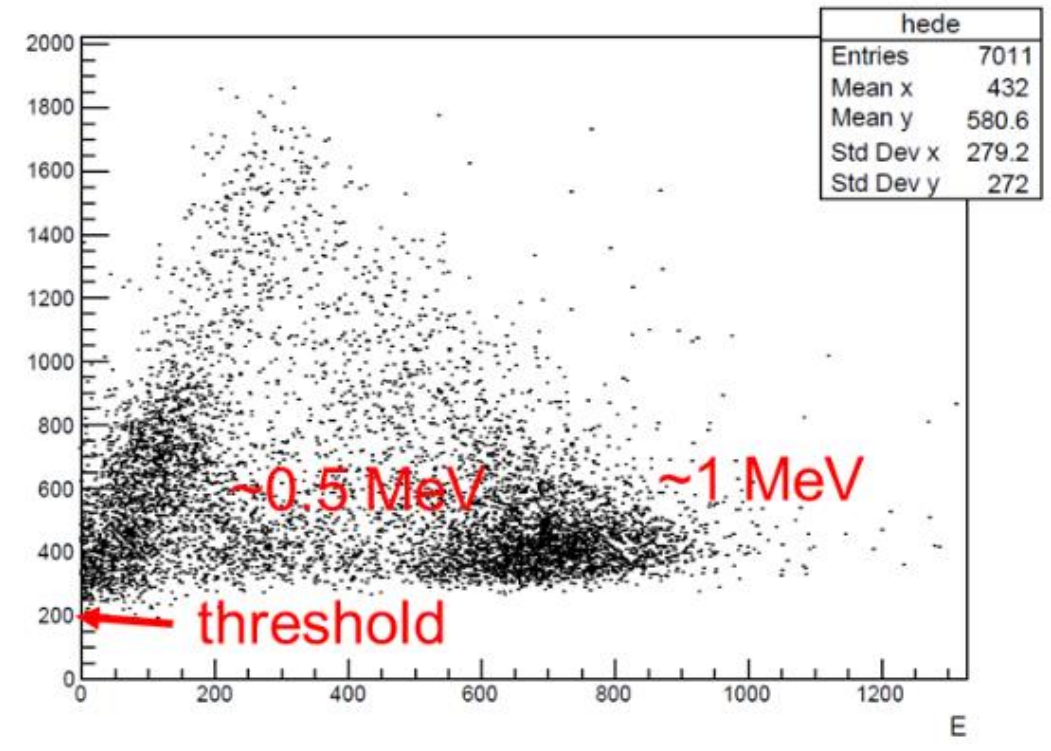
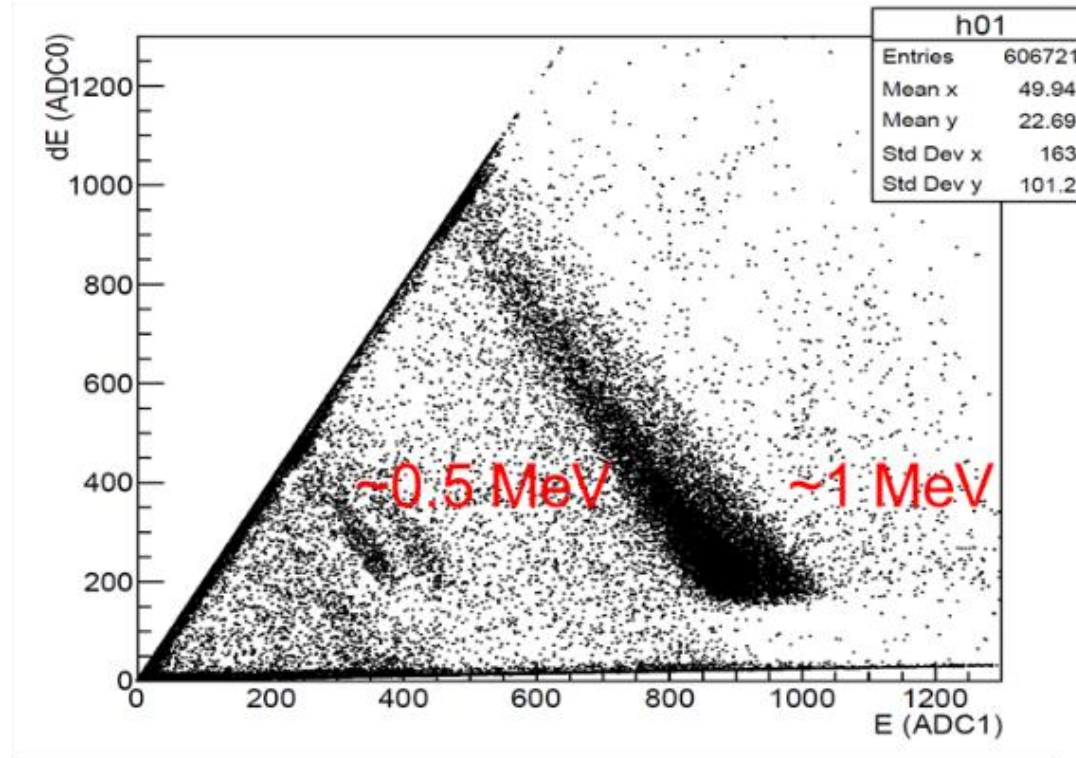

Electronics

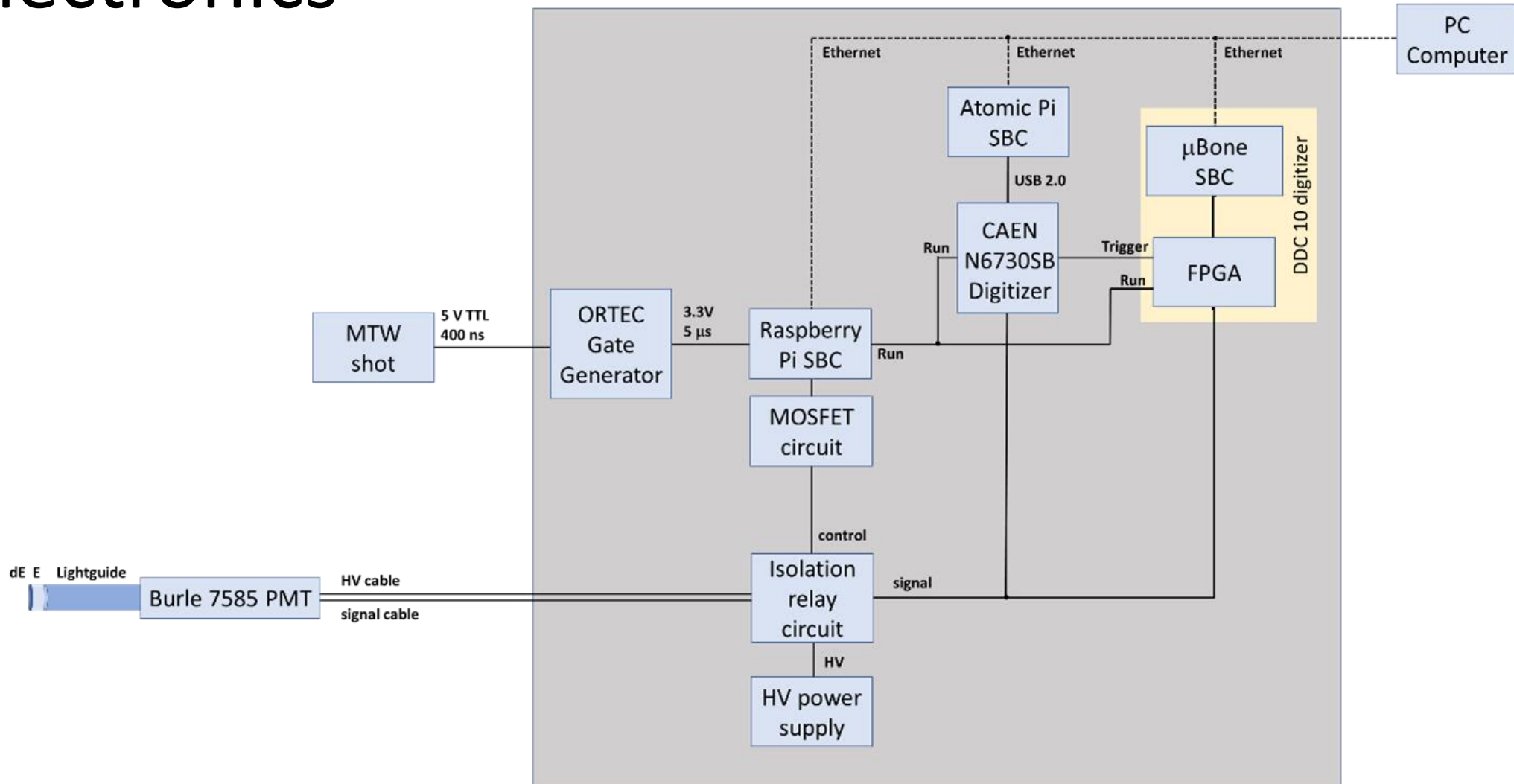



Results

Laser Target: CD
Nuclear Target:
Lithium

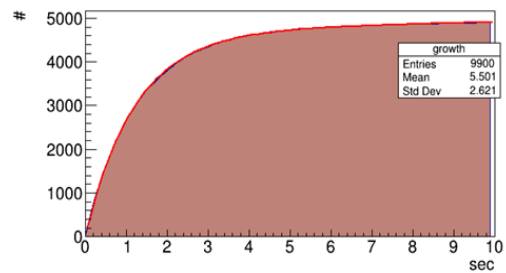
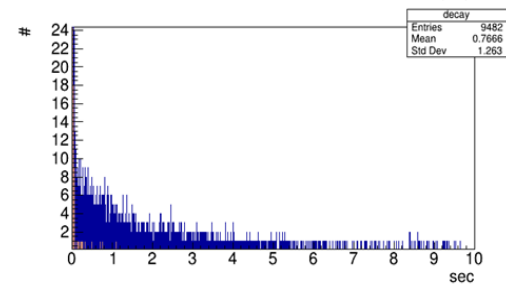
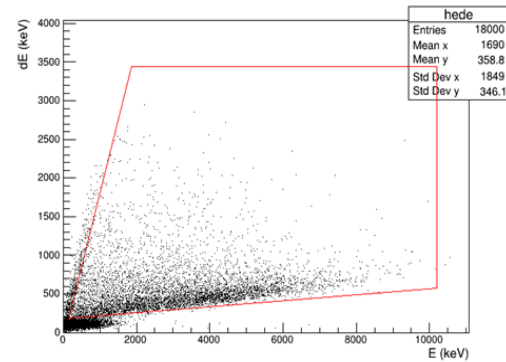

${}^7\text{Li}(d,p){}^8\text{Li}$

Laser Target: CH₂
Nuclear Target:
Lithium

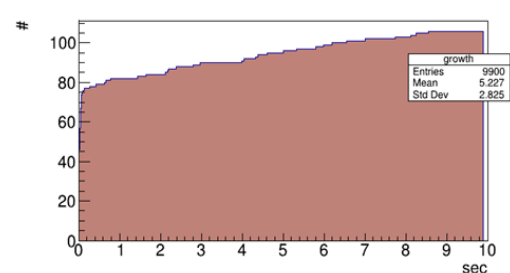
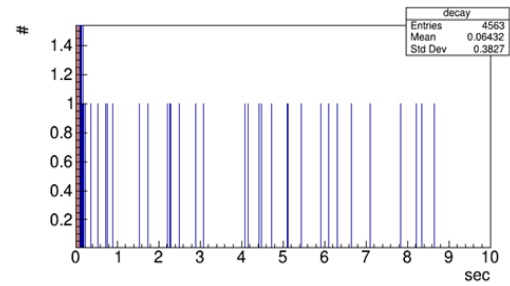
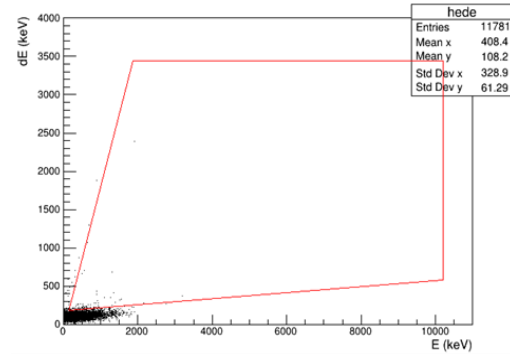

${}^7\text{Li}(p,?)$

Laser Target: CD
Nuclear Target:
Blank

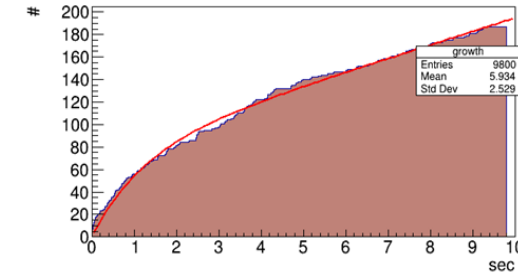
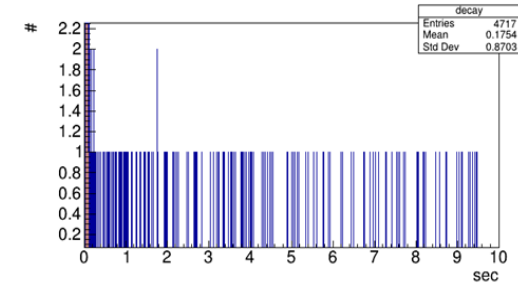
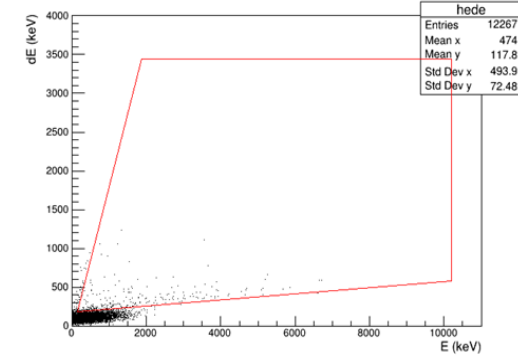

${}^{65}\text{Cu}(d,p){}^{66}\text{Cu}$?



Yield Results

$$Y_{Li} = \int D(E) \cdot N_{Li} \cdot T_{Li} \cdot SA \cdot CS(E) dE$$

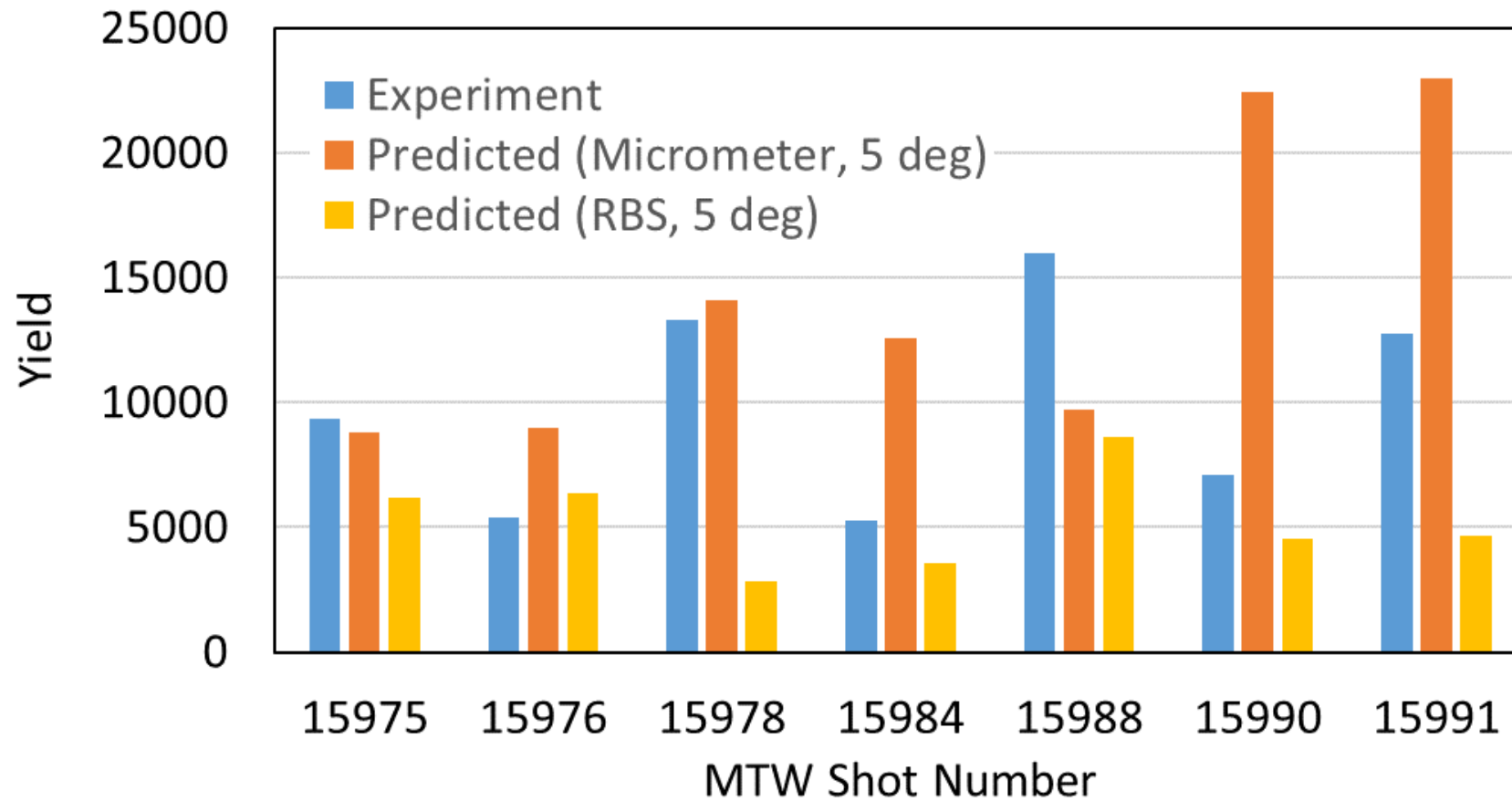

Future Plans

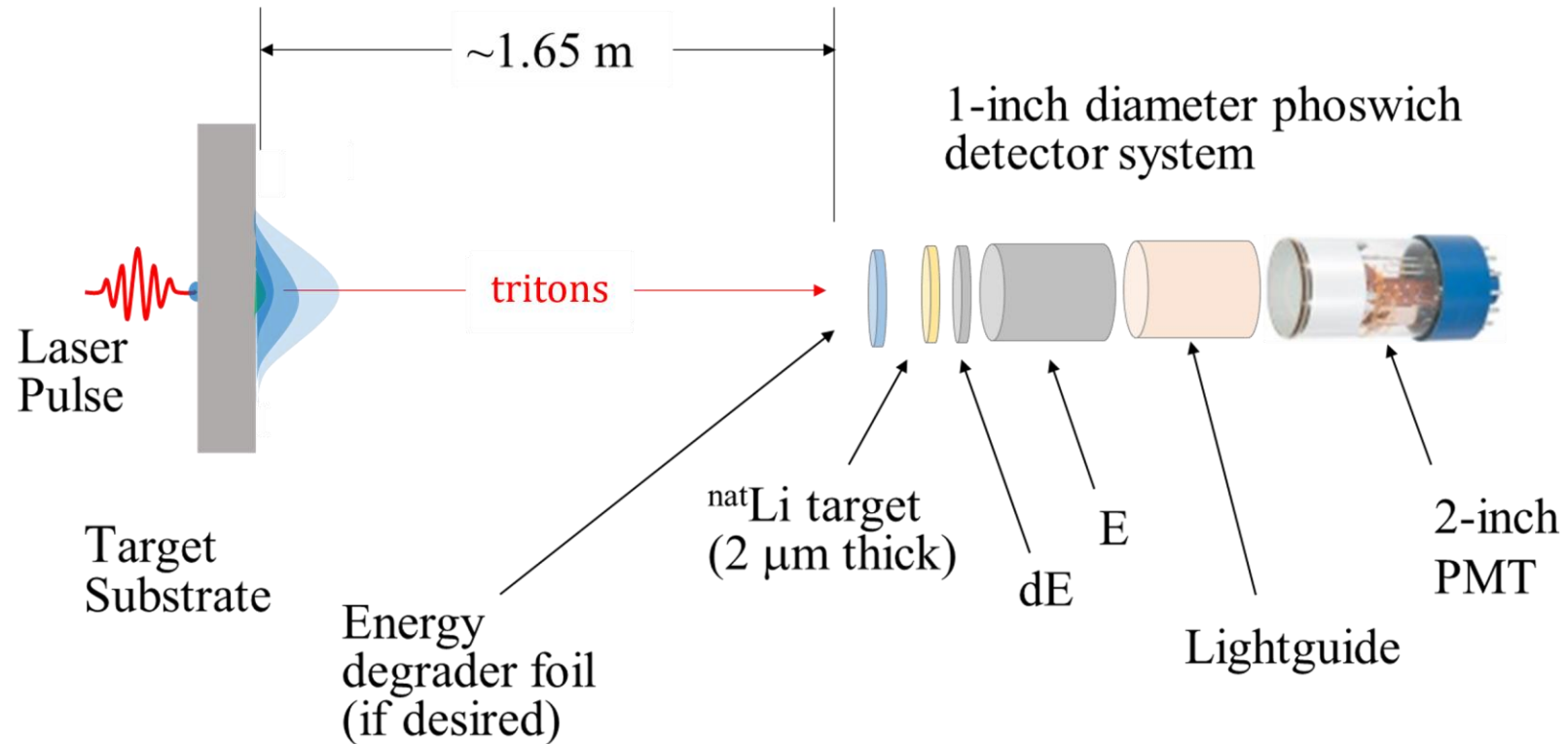

Thomson Parabola

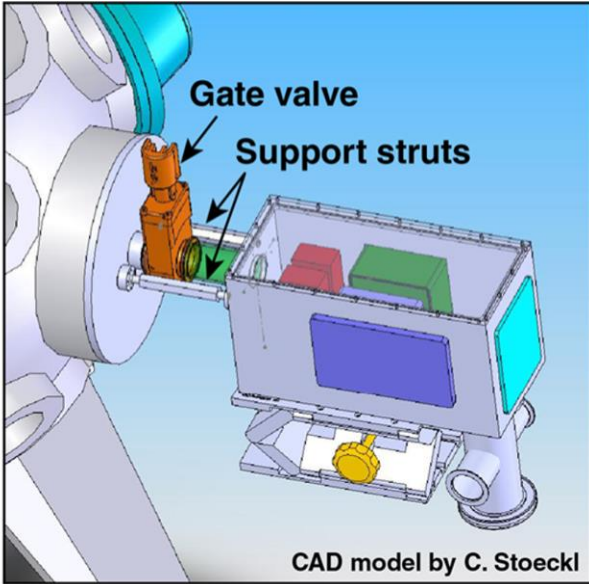
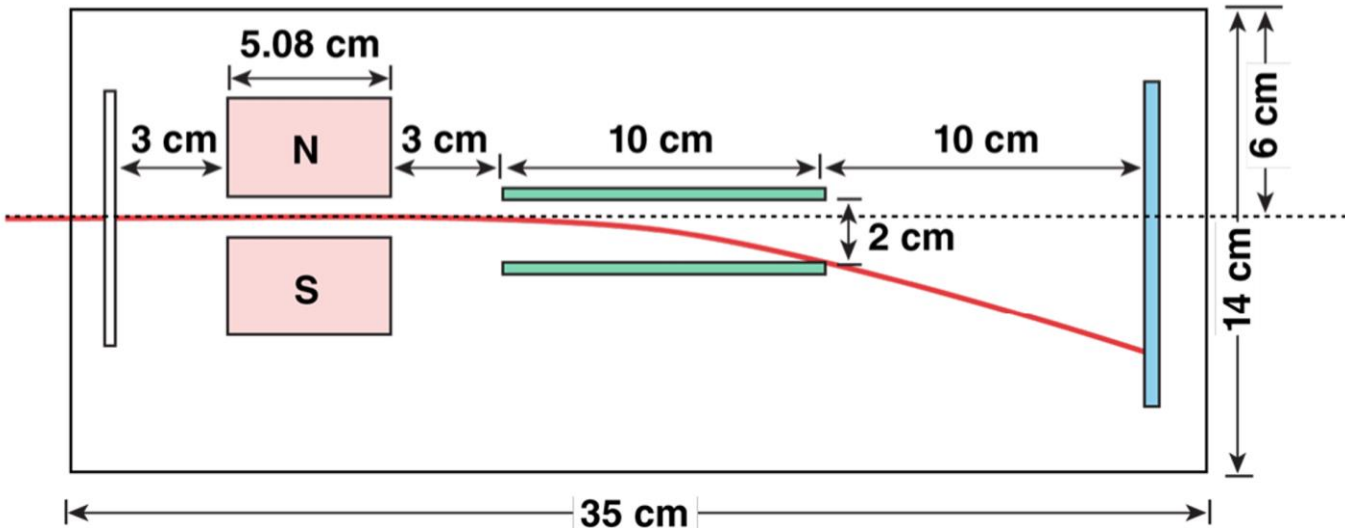

Thomson Parabola

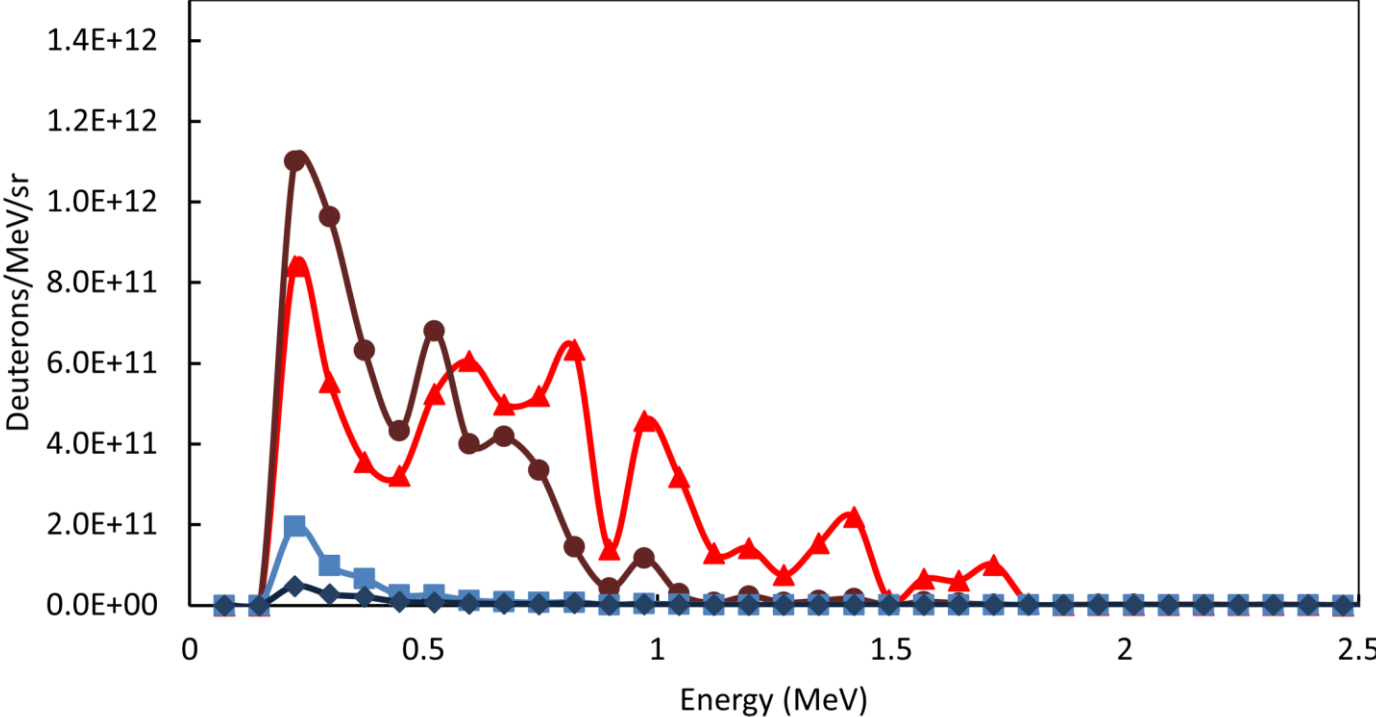

TOF data

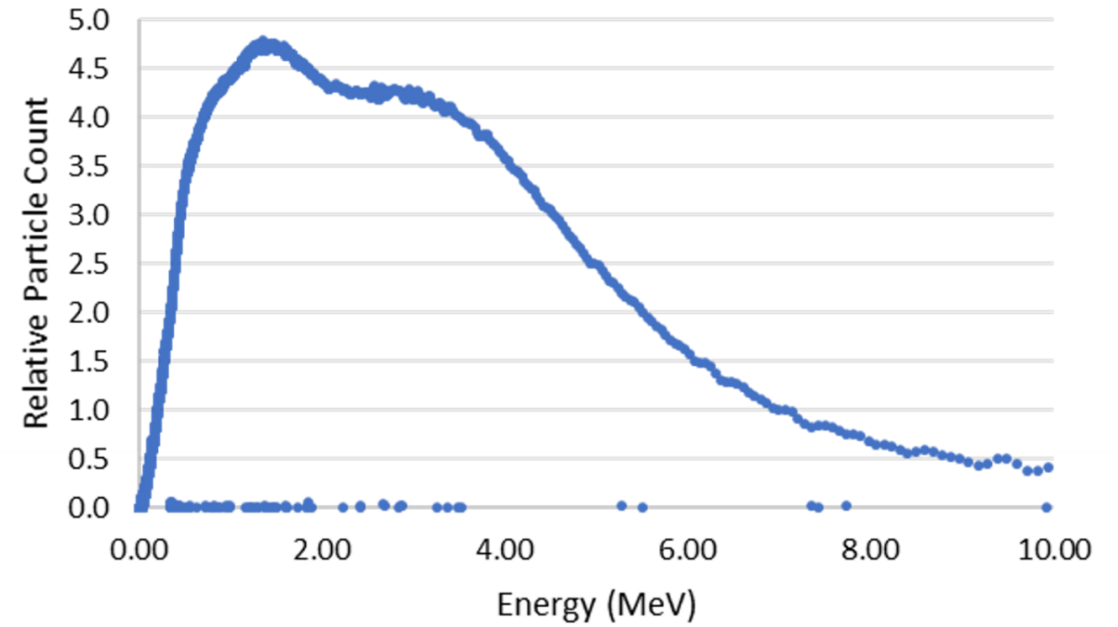
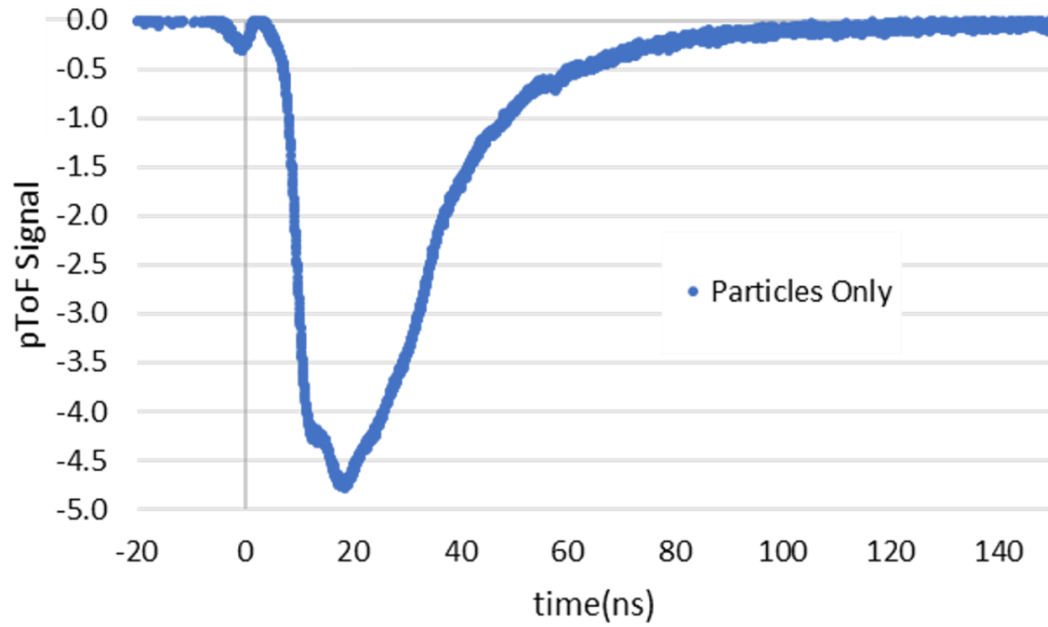

TOF data

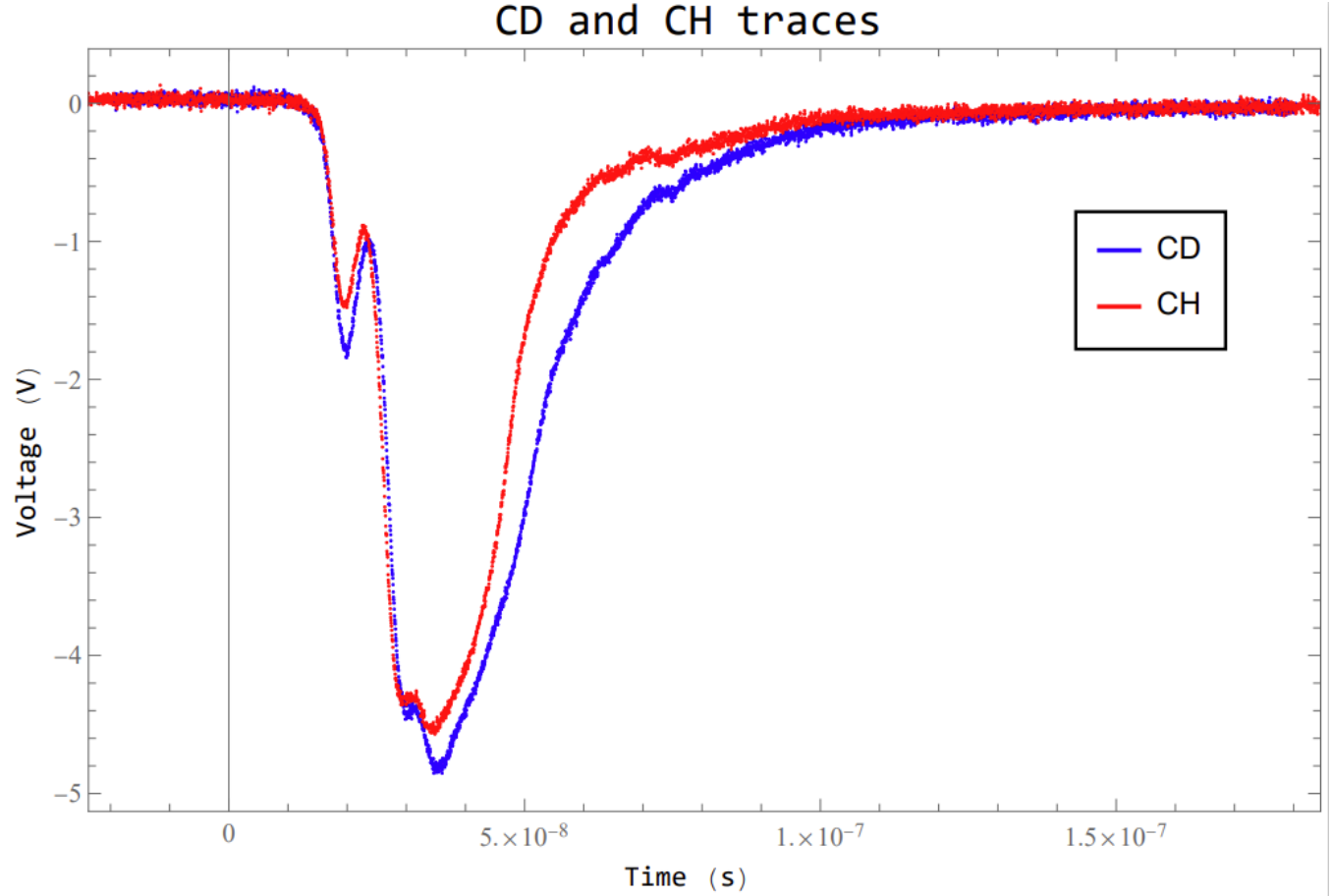

Bi-207 Spectrum

