

Mössbauer Sources for Undergraduate Labs

Keith Mann & Mark Yuly
Department of Physics
Houghton College
Houghton, NY

Overview

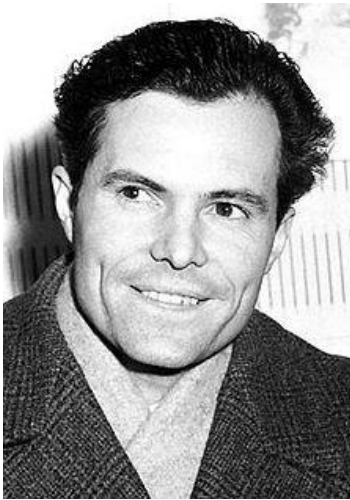

http://en.wikipedia.org/wiki/Rudolf_M%C3%B6ssbauer

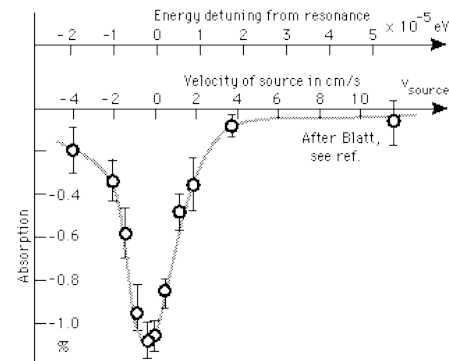

<http://hyperphysics.phy-astr.gsu.edu/%E2%80%8Chbase/nuclear/imgnu/moss2.gif>

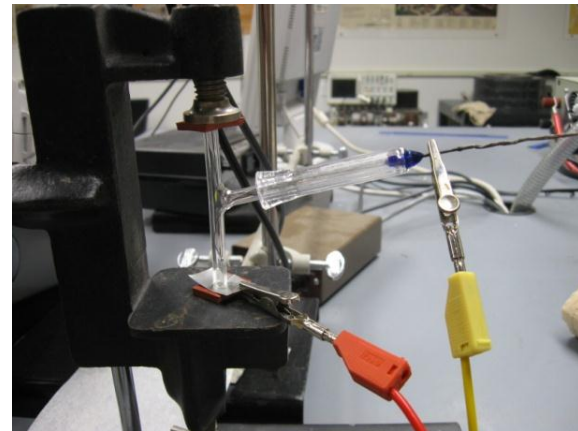
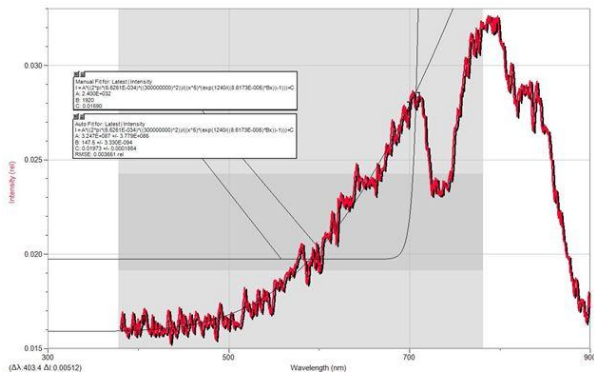

Resonance and the Doppler Effect

- Line width $\sim 10^{-6} \text{eV}$
- $|P_R| = |P_Y|$

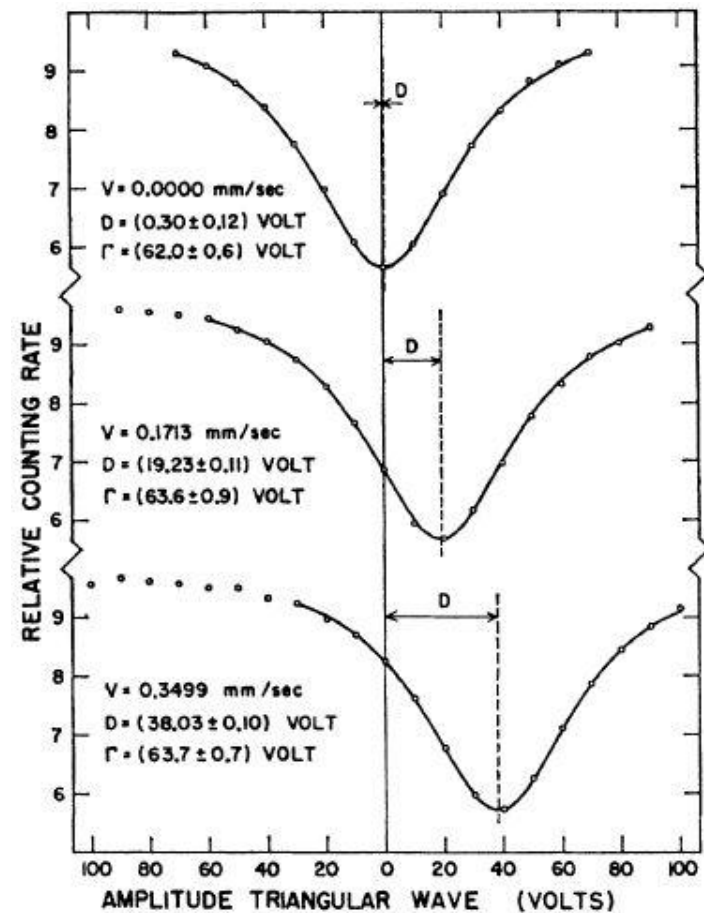
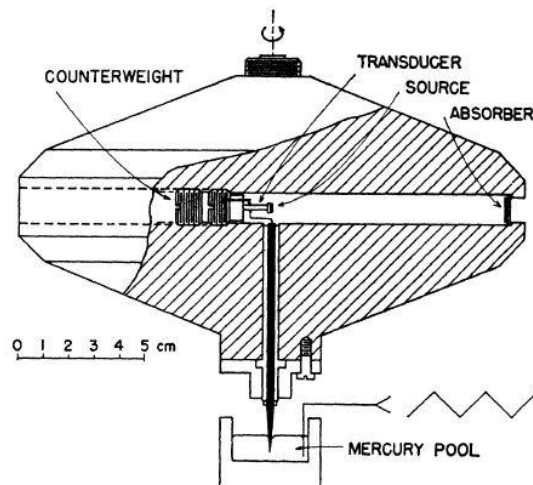

Longitudinal Doppler Effect

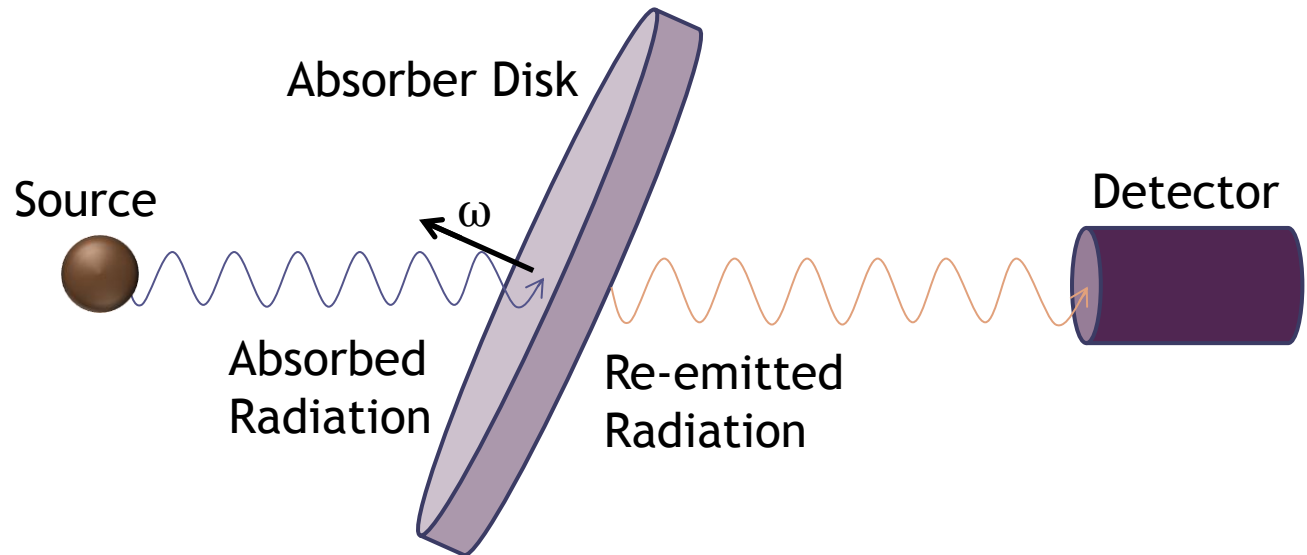

Count Rate Estimates

- $t_{\text{collection}} = 100\text{s}$
- Source Activity = $5 \times 10^{-6}\text{Ci}$
- Transmitted ~ 519 incidents

Mössbauer Source Material

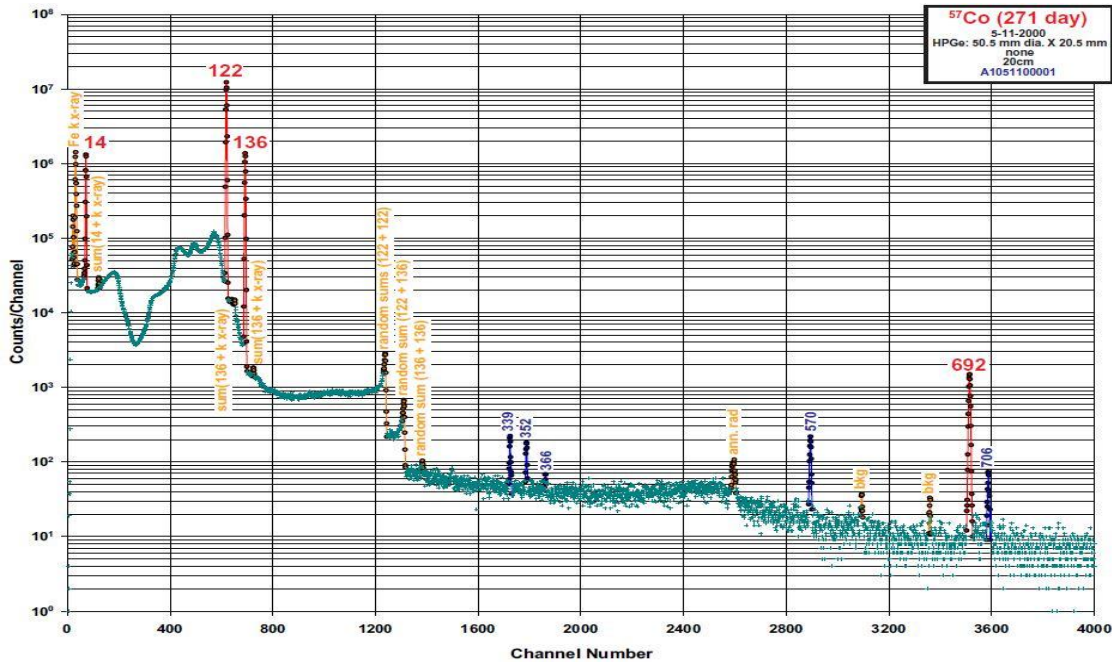

⁵⁷Co (271.74 day) Decay Scheme

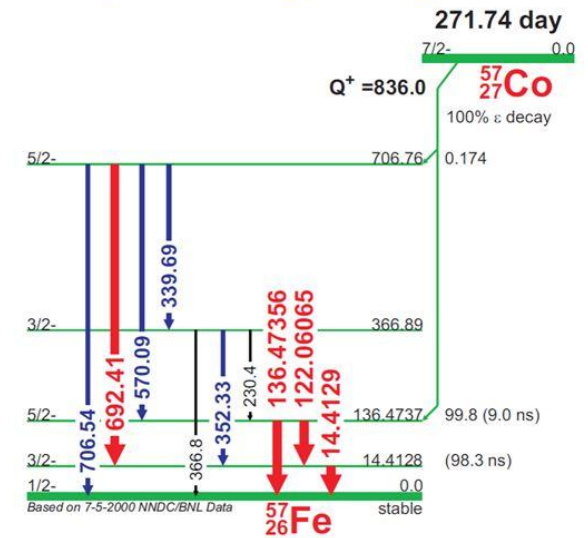

Electroplating the Source

- ^{57}Co & $^{59}\text{Co}\cdot 6\text{H}_2\text{O}$ with HCl

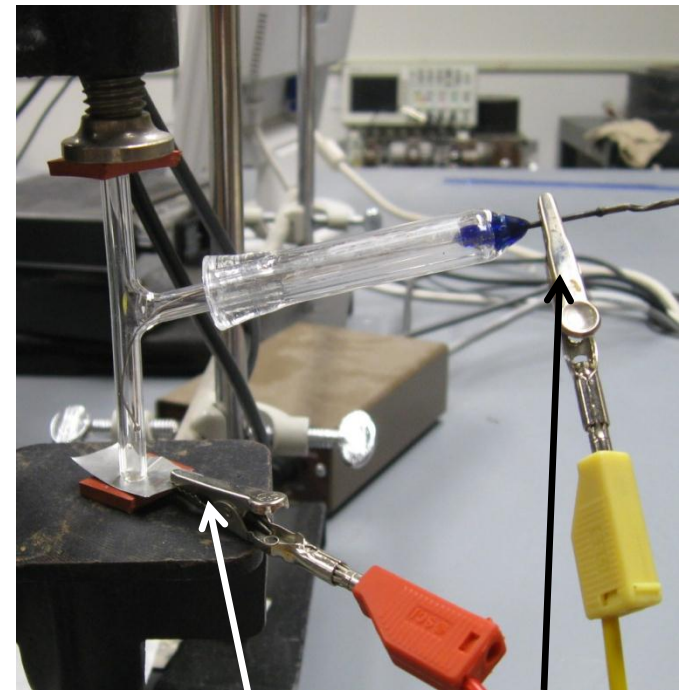
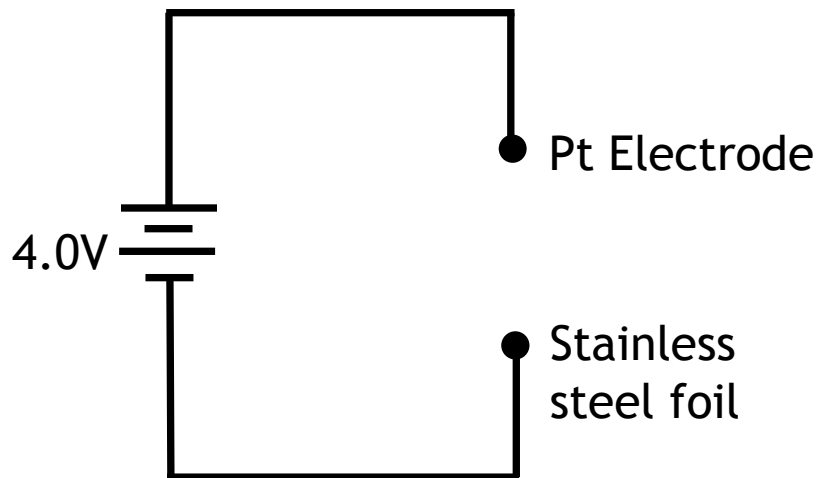

Negative lead Positive lead

Heating the Source

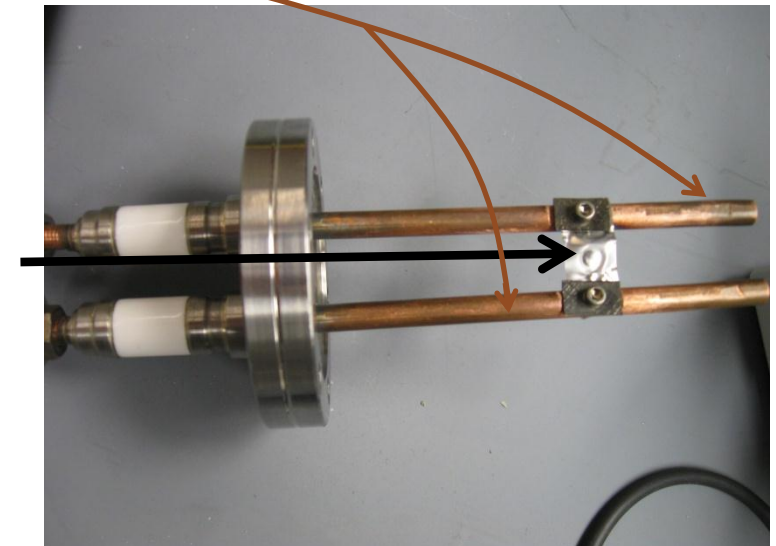
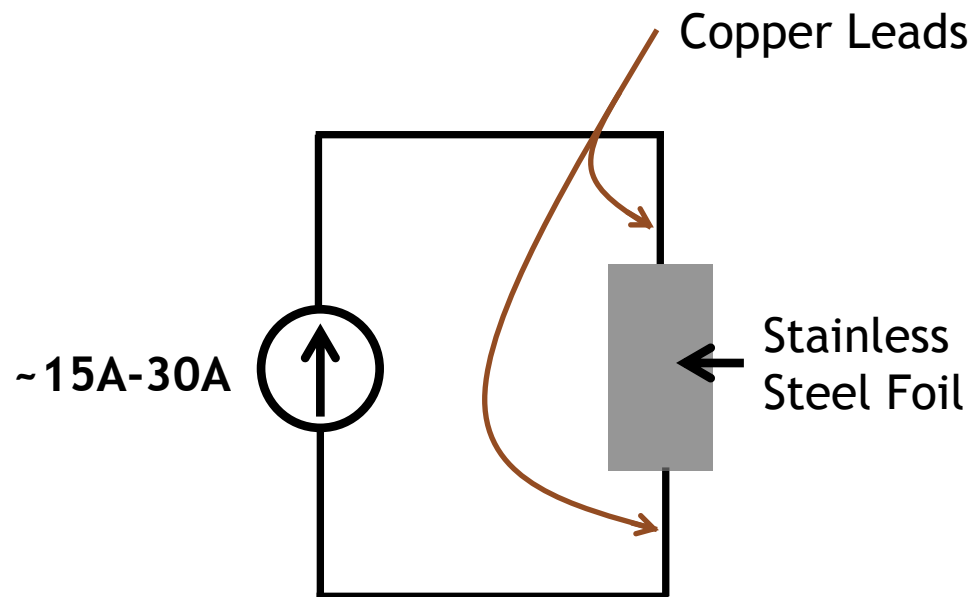

Measuring the Temperature

- Needs to reach 1000°C

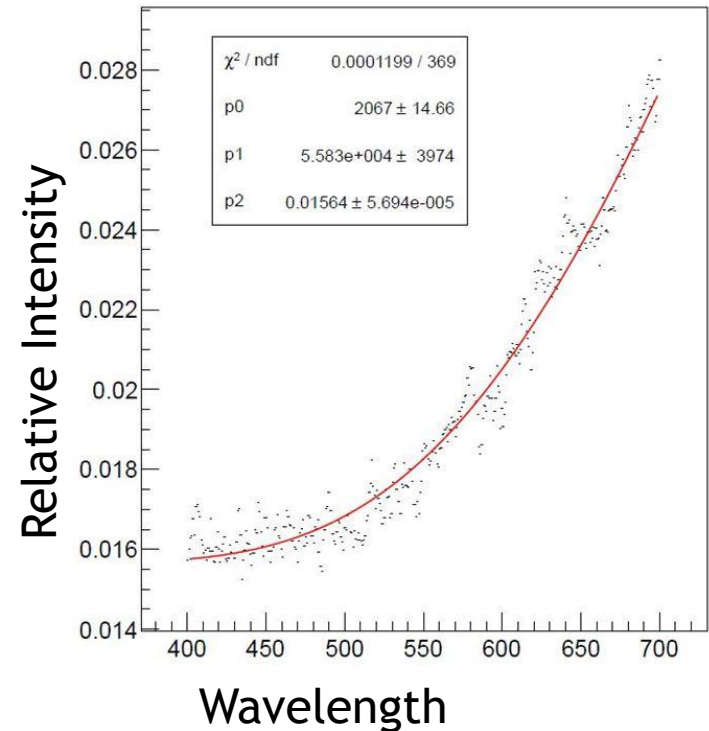
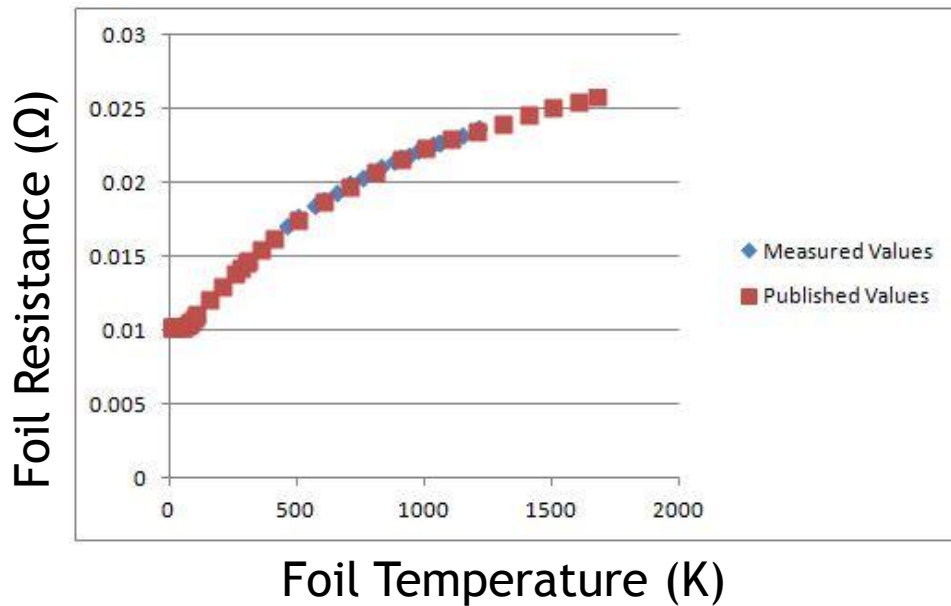

Electroplating the Foil

- HCl current
~1750 μ A
- 5 μ L of ^{57}Co

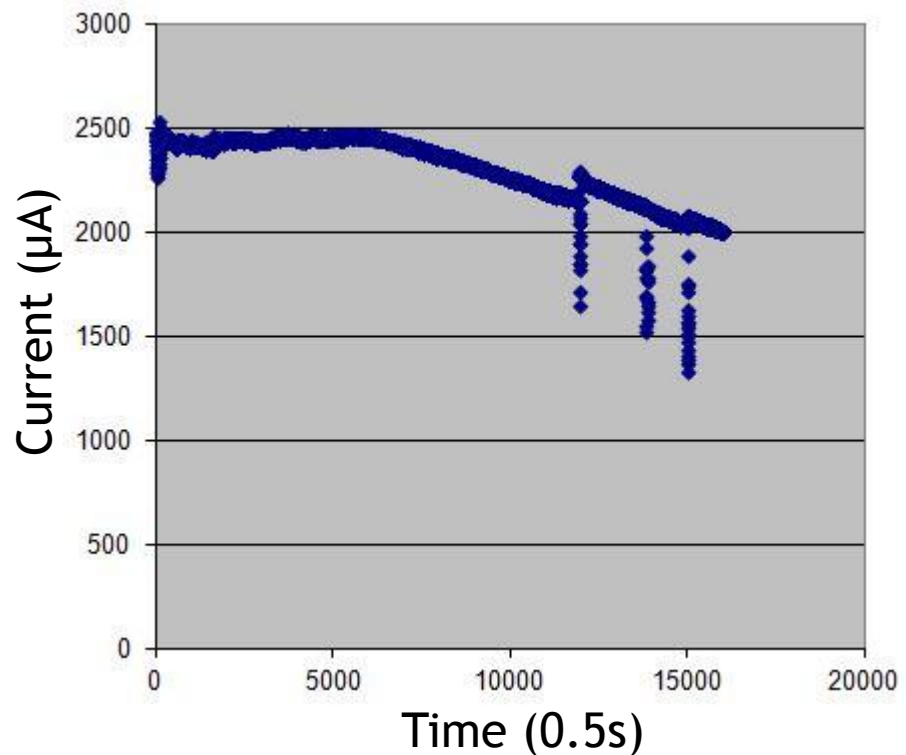

Future Plans

- Mixing ^{57}Co with more $^{59}\text{CoCl}_2 \cdot 6\text{H}_2\text{O}$
- Successfully electroplate and bake ^{57}Co source
- Observe both Longitudinal and Transverse Doppler Effect

References

- Kundig Phys Rev 129 2371 (1963)
- Bearden et al AJP 32 109 (1964) (Mossbauer)
- Kholmetskii et al Phys Scr 77 035302 (2008)
- Kholmetskii et al Phys Scr 79 065007 (2009)
- Frauenfelder, Hans. *The Mossbauer Effect*. S.l.: W A Benjamin Inc., 1963. Print.
- "Mossbauer Absorbtion Ir191." *hyperphysics*. N.p., n.d. Web. 5 Apr. 2013. <hyperphysics.phy-astr.gsu.edu/%E2%80%8Chbase/nuclear/mossb.html>